

# IOWA STORM WATER MANAGEMENT MANUAL

## 9.04 DESIGN AND MODELING OF OUTLET CONTROLS



IOWA DEPARTMENT OF  
NATURAL RESOURCES

# TABLE OF CONTENTS

## CONTENTS

<b>9.04-1 OVERVIEW</b>	<b>1</b>	<b>9.04-6 LOW-FLOW INLET CONSIDERATIONS</b>	<b>16</b>
A. Introduction .....	1	A. Subsurface Inlet Designs.....	16
B. General Types of Controls .....	1	1. Hooded Outfalls .....	16
<b>9.04-2 ORIFICES/ CLOSED CONDUITS</b>	<b>2</b>	2. Water Level Control Structures .....	16
A. Perforated Riser .....	2	3. Upturned Risers .....	17
B. Orifices .....	4	B. Subsurface Inlet Line Protections .....	18
C. Pipes and Culverts.....	5	<b>9.04-7 TRASH RACKS AND GRATES</b>	<b>19</b>
<b>9.04-3 WEIR CONTROLS</b>	<b>6</b>	A. General Parameters .....	19
A. Rectangular Weirs.....	7	B. Head Losses and Open Area .....	21
B. Broad-crested Weirs.....	7	<b>9.04-8 AUXILIARY SPILLWAYS</b>	<b>23</b>
C. V-notch Weirs.....	9	A. General Parameters .....	23
D. Trapezoidal (Cipolletti) Weir .....	9	B. Flow and Velocity Calculations.....	25
E. Proportional Weirs.....	11	C. Regulatory Requirements.....	25
<b>9.04-4 STANDPIPES AND INLETS</b>	<b>12</b>		
<b>9.04-5 MULTI-STAGE OUTLETS</b>	<b>13</b>		
A. Design of Multi-stage Outlets.....	14		

Some items of emphasis are listed in **bold blue text**.

# 9.04-1 OVERVIEW

## A. INTRODUCTION

---

The outflow from a stormwater management practice depends on the type and the size of the outlet structure. A relationship between the stage and the discharge can be determined from the hydraulics of these structures. The selected outlet design provides the ability to regulate flow.

The outlet may be configured as a single outlet, but typically the outfall will need to be configured with multiple outlet stages and types to achieve effective flow control to meet USC criteria for both small and large storms. Typically, lower stages are designed to pass lower flow rates during more common events. Perforated risers, orifices and smaller-diameter pipes are often used for this purpose. During large events, outfall stages that are elevated above the bottom of the practice are often used to allow higher levels of flow than the smaller, lower-stage outlets can be expected to pass. Larger pipes or weirs often serve this function. These can be built into the sides or top of an area intake structure to which the lower-stage controls are typically connected. A larger-diameter primary spillway pipe is most often used to direct runoff from this multi-stage control structure to the outfall.

In almost all cases, stormwater practices need to have an auxiliary spillway which directs overflows along a specific path, should a very large event occur. Auxiliary spillways are usually longer weirs constructed out of earth materials. In some cases they are protected with Turf Reinforcement Mats, articulated concrete blocks or mats or other forms of protection to prevent surface erosion.

Understanding the hydraulics of each of these outlet types allows the designer to develop a stage-discharge relationship. This can be input into routing models, allowing the actual performance of the stormwater management practice to be evaluated. From this routing, it can be determined if the release rate restrictions to comply with the USC requirements for a given site have been achieved. This section provides an overview of outlet structure hydraulics and design for stormwater management facilities.

## B. GENERAL TYPES OF CONTROLS

---

Outfall controls within this section are generally grouped into two categories: (1) closed conduits (perforated risers, orifices, pipes and culverts) and (2) overflow weirs.

Closed Conduits are often used when greater levels of flow restriction are required. These controls are often used for lower-stage controls to control flow rates during smaller storm events. Larger-diameter pipes are often used as the primary spillway from the multi-stage outfall to the outlet. Weirs typically provide less control as water levels rise, so they are often used to control flow rates during larger storm events.

## 9.04-2 ORIFICES/CLOSED CONDUITS

Flow through orifices and conduits remains fairly restricted even as water levels upstream of the opening rise. For this reason, they are effective for use when greater flow restrictions are desired.

### A. PERFORATED RISER

A perforated riser may be used in situations where flowrates need to be restricted to a very low level. This is conceptually illustrated in Figure 9.04-2-1. The riser is a vertical pipe perforated with equally-spaced round holes. Water enters through the holes and is allowed to flow into the outlet pipe conduit.

A perforated riser is an effective approach when calculations show that a very small diameter orifice (smaller than 4") is needed to control flow. A perforated riser may also be placed above a small orifice that controls flow. Multiple small openings reduces the chance that the small diameter orifice outfall will become completely clogged. This arrangement also prevents debris that would be large enough to plug the control orifice from passing through the riser. To convey this concept, Figure 9.04-2-1 shows the orifice located just below the openings in the riser. However, in practice it is recommended to place such an orifice where it can be accessible for maintenance, such as in the cap of a drain pipe within an outfall structure (refer to Figure 9.04-2-2)

Figure 9.04-2.1: Perforated riser variable definitions.<sup>(1)</sup>

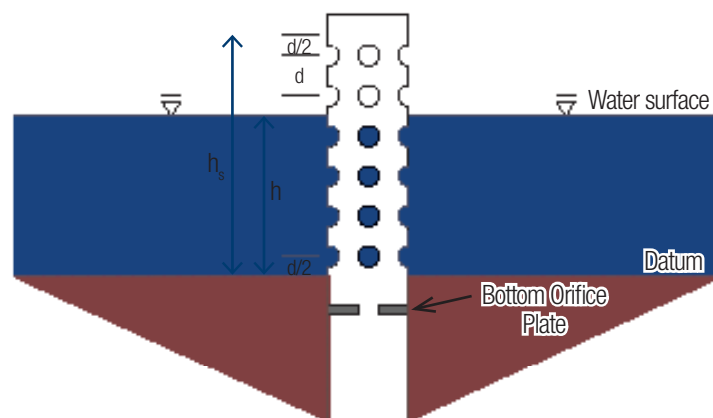

$d$  = diameter of each opening

For definitions of  $h$  and  $h_s$ , refer to Equation 9.04-2.1

A formula was developed by McEnroe (1988) in reference to Figure 9.04-2-2 that defined the intake characteristics of a perforated riser without a bottom orifice plate and is expressed as:

Equation 9.04-2.1: Equation for flow through a perforated riser with circular openings

$$Q = C_s \left( \frac{2A_s}{3h_s} \right) \sqrt{2g} h^{3/2}$$

Where:

$C_s$  = dimensionless discharge coefficient of the side holes

$A_s$  = total area of the side holes (ft<sup>2</sup>)

$h_s$  = length of the perforated segment of the riser pipe (ft)

$h$  = elevation difference between water surface and bottom of lowest opening (ft)

$g$  = gravitational constant 32.2 ft/s<sup>2</sup>

The variables  $h$  and  $h_s$  are measured from the same datum. That datum is set at half of the vertical spacing between the centerlines of horizontal rows of openings (noted as “ $d$ ” in Figure 9.04-2-1). The coefficient “ $C_s$ ” is 0.611 (McEnroe et al, 1988). Equation 9.04-2-1 is only valid when  $h < h_s$ . Also, this equation will represent the stage-discharge relationship through the perforated riser as long as the capacity of the downstream outlet conduit (or control orifice) is greater than the capacity of the perforated riser.<sup>(1)</sup>

If a downstream orifice is used as the flow control, the downstream opening would be designed using the equation for orifices. In that arrangement, it is advised to size the perforated riser to pass at least twice the design flowrate expected to pass through the downstream control orifice. This ensures that flow through the system is not reduced by clogging around the perforated riser.

Clean, small-diameter aggregate may be placed around the perforated riser to act as a filter to prevent debris from clogging the openings of the riser. In such an arrangement, the minimum size of the selected aggregate should be larger than the openings of the riser.<sup>(1)</sup>

Figure 9.04-2.2: Example Perforated Riser arrangement

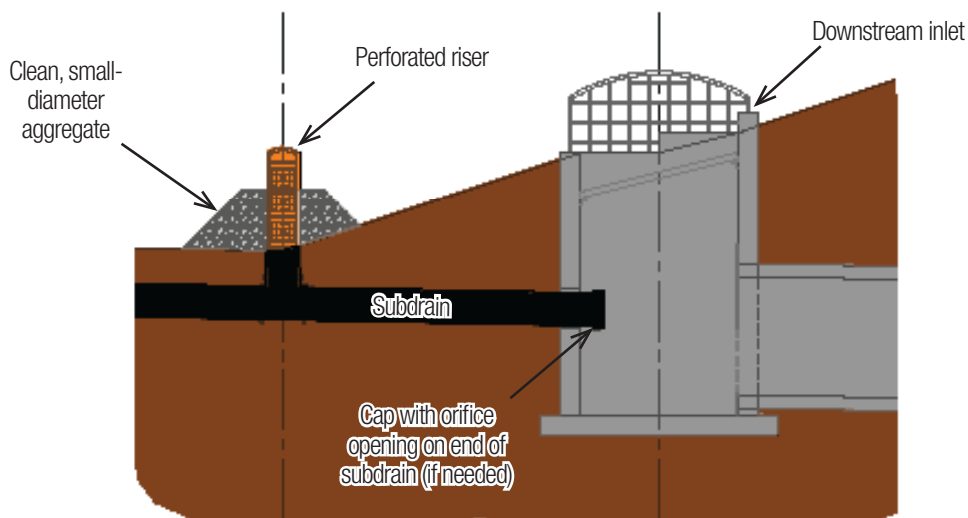

1. Figure 9.04-2-1 and text above adapted from Akan, A. Osman, Urban Stormwater Hydrology, A Guide to Engineering Calculations (CRC Press, 1993)

**TABLE 9.04-2.1: MAXIMUM NUMBER OF PERFORATED COLUMNS**

(INCHES)	HOLE DIAMETER			
RISER DIAMETER	1/4	1/2	3/4	1
4	8	8	±	±
6	12	12	9	±
8	16	16	12	8
10	20	20	14	10
12	24	24	18	12

## B. ORIFICES

An orifice is a circular or rectangular opening of a prescribed shape and size. The flow rate through the orifice depends on the height of the water above the opening and the size and edge treatment of the orifice. For a single orifice, as illustrated in Figure 9.01-2-3, the orifice discharge can be determined using the standard orifice equation below.

Equation 9.04-2.2: Equation for flow through an orifice

$$Q = C_d A_o \sqrt{(2gh)}$$

Where:

Q = the orifice flow discharge (cfs)

$C_d$  = dimensionless coefficient of discharge

$A_o$  = cross-sectional area of orifice or pipe (ft<sup>2</sup>)

g = acceleration due to gravity (32.2 ft/sec<sup>2</sup>)

$D_o$  = diameter of orifice or pipe (ft)

h = effective head on the orifice, from the center of orifice to the water surface (ft)

Equation 9.04-2.3: For circular orifices

$$A_o = \frac{\pi D_o^2}{4}$$

Equation 9.04-2.4: For rectangular orifices

$$A_o = bD$$

Where: b = width (in ft)

D = depth (height in ft)

Typical values for  $C_d$  are 0.6 for square-edge uniform entrance conditions, and 0.4 for ragged-edge orifices (FHWA, 1996).

If the orifice discharges as a free outfall (unsubmerged), then the effective head is measured vertically from the CENTER of the orifice to the upstream (headwater) surface elevation. If the orifice discharge is submerged, then the effective head is the difference in elevation of the headwater and tailwater surfaces as shown in Figure 9.04-2.3.

Figure 9.04-2.3: Measurement of Head Conditions for Unsubmerged and Submerged Orifices

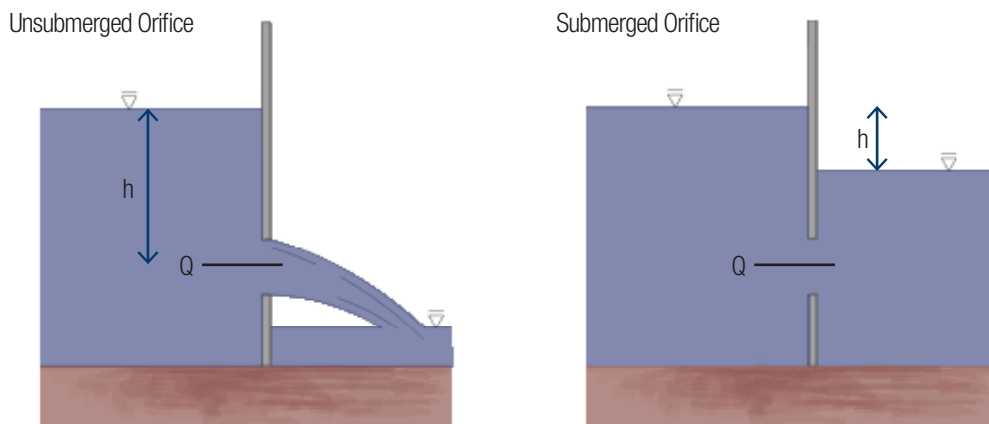

## C. PIPES AND CULVERTS

Pipes and culverts are often used as outlet control structures. In multi-stage systems, weir and/or orifice elements located upstream of the outfall pipe may be the limiting factor in release rates, if their capacity is less than that of the outfall pipe. When that is not the case, or if single-stage outfalls are planned, the capacity of the outfall culvert or pipe system may be needed. For methods to calculate pipe or culvert capacity, refer to Chapter 2 of the Design Manual of SUDAS or Chapters 7 and 8 for the Urban Drainage Manual (Hydraulic Engineering Circular No. 22, Third Edition, Sept 2009; Federal Highway Administration).<sup>(2)</sup>

### NOTE

Mismeasurement of head condition ( $h$ ) in free outfall conditions is a common error observed on stormwater reviews. Some calculations mistakenly measure head conditions from the water surface to the bottom of the opening, rather than its center.

### NOTE

For low-flow conditions when the culvert is not full, the opening of the pipe may act like a weir. In such cases, the outflow through the pipe should be evaluated at various elevations as both a pipe and a weir, using the lower flow rate of the two values for design.

2. Text above adapted from U.S. Dept. of Transportation Urban Drainage Design Manual (Hydraulic Engineering Circular No. 22, Third Edition, September 2009, Revised August 2013)

## 9.04-3 WEIR CONTROLS

Rectangular broad-crested weirs, overflow spillways and sharp-crested weirs are included in this group. The discharge over these structures is determined using the general form of the equation (Brater and King, 1976). A sharp-crested weir is a relatively thin, vertical element that flow passes across. A vertical wall or the openings on the top of an inlet structure are examples. A broad-crested weir requires flow to pass over a nearly level surface for a longer distance. Overflow across an auxiliary spillway is an example where flow may pass across several feet of the spillway crest before it can crest over the downslope beyond.

Equation 9.04-3.5: Weir equation

$$Q = C_w L H^{3/2}$$

Where:

$C_w$  = weir discharge coefficient (use values from Table 9.04-3.1)

$L$  = effective weir length (ft)

$H$  = water depth above the crest (ft)

$Q$  = flow over weir (cfs)

In contrast to closed conduits and orifices, flow across a weir increases considerably with deeper flow depths. For this reason, they are less effective for use when greater flow restrictions are desired.

Figure 9.04-3.1: Graph comparison of flow across a weir vs. head condition

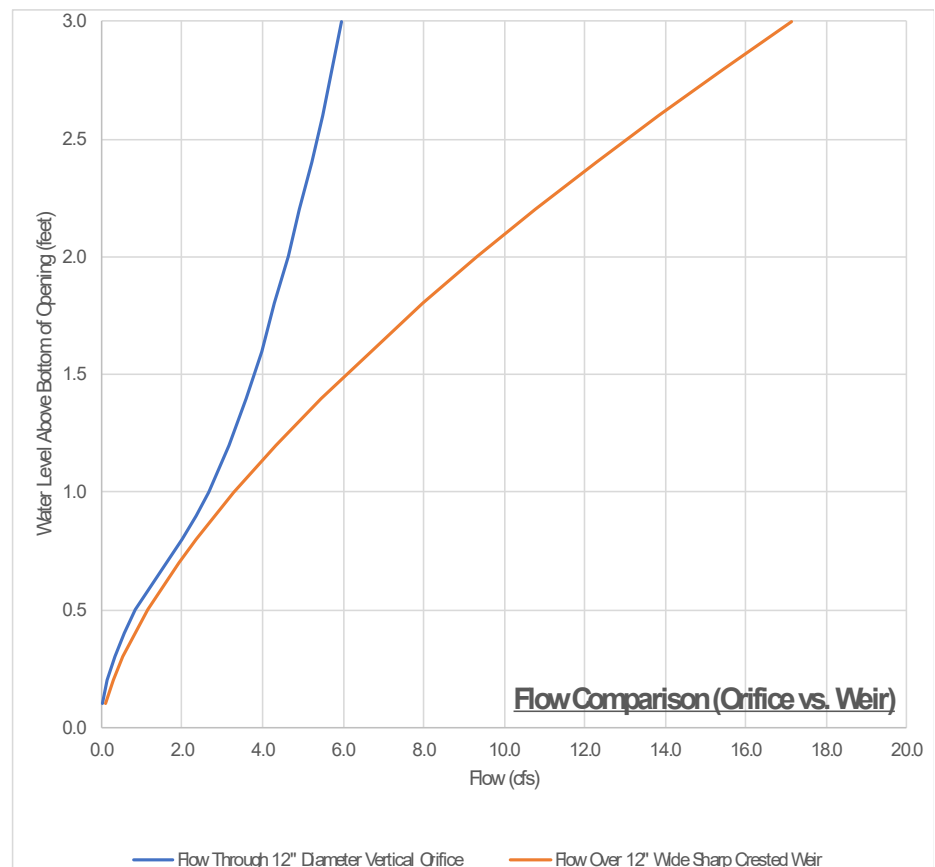



## A. RECTANGULAR WEIRS

The openings on the top or side of an inlet structure are often designed as rectangular, sharp-crested weirs. Flow across the weir is determined using Equation 9.04-3-1, using a  $C_w = 3.33$ .

Figure 9.04-3.2: Rectangular Weirs

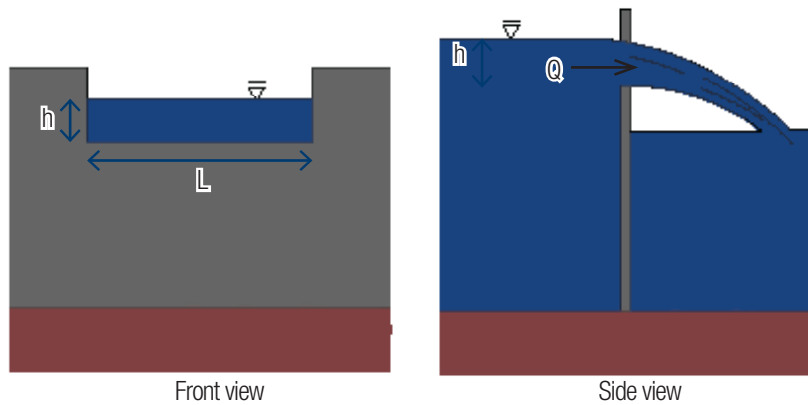

## B. BROAD-CRESTED WEIRS

A weir in the form of a relatively long, raised channel control crest section is a broad-crested weir. This arrangement is commonly applied to auxiliary spillways. The flow control section can have different shapes, such as trapezoidal, triangular or circular. A minimum value for  $C_w$  of 2.6 is often used by design software programs.

Figure 9.04-3.3: Side, cross-section illustrations of a broad-crested weir

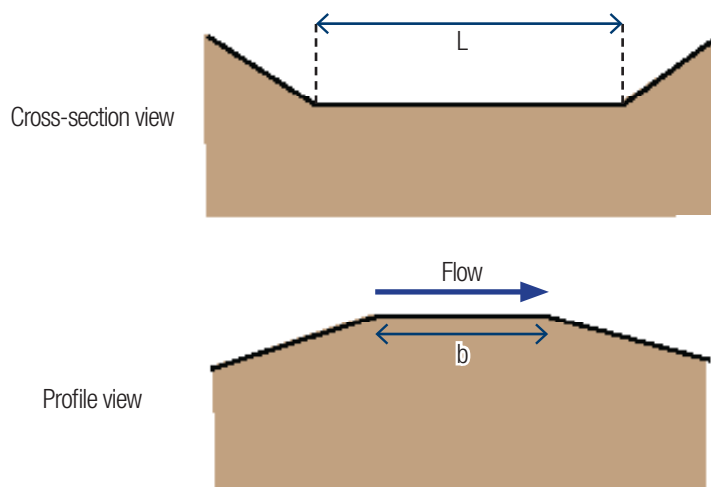

True broad-crested weir flow will occur when upstream head above the crest is between the limits of about 1/20 and 1/2 the crest length in the direction of flow (USBR, 1997). If the upstream edge of a broad-crested weir is so rounded as to prevent contraction, and if the slope of the crest is as great as the loss of head due to friction, flow will pass through critical depth at the weir crest; this gives the maximum  $C_w$  value of 3.087. Information on  $C$  values as a function of weir crest breadth and head is given in Table 9.04-3-1.<sup>(3)</sup>

TABLE 9.04-3.1: VALUES OF  $C_w$  FOR DIFFERENT WIDTH AND HEAD CONDITIONS.

Head (h) <sup>1</sup> (feet)	Weir Crest Breadth (b) (feet)										
	0.50	0.75	1.00	1.50	2.00	2.50	3.00	4.00	5.00	10.00	15.00
0.2	2.80	2.75	2.69	2.62	2.54	2.48	2.44	2.38	2.34	2.49	2.68
0.4	2.92	2.80	2.72	2.64	2.61	2.60	2.58	2.54	2.50	2.56	2.70
0.6	3.08	2.89	2.75	2.64	2.61	2.60	2.68	2.69	2.70	2.70	2.70
0.8	3.30	3.04	2.85	2.68	2.60	2.60	2.67	2.68	2.68	2.69	2.64
1.0	3.32	3.14	2.98	2.75	2.66	2.64	2.65	2.67	2.68	2.68	2.63
1.2	3.32	3.20	3.08	2.86	2.70	2.65	2.64	2.67	2.66	2.69	2.64
1.4	3.32	3.26	3.20	2.92	2.77	2.68	2.64	2.64	2.65	2.67	2.64
1.6	3.32	3.29	3.28	3.07	2.89	2.75	2.68	2.66	2.65	2.64	2.63
1.8	3.32	3.32	3.31	3.07	2.88	2.74	2.68	2.66	2.65	2.64	2.63
2.0	3.32	3.31	3.30	3.03	2.85	2.76	2.27	2.68	2.65	2.64	2.63
2.5	3.32	3.32	3.31	3.28	3.07	2.89	2.81	2.72	2.67	2.64	2.63
3.0	3.32	3.32	3.32	3.32	3.20	3.05	2.92	2.73	2.66	2.64	2.63
3.5	3.32	3.32	3.32	3.32	3.32	3.19	2.97	2.76	2.68	2.64	2.63
4.0	3.32	3.32	3.32	3.32	3.32	3.32	3.07	2.79	2.70	2.64	2.63
4.5	3.32	3.32	3.32	3.32	3.32	3.32	3.32	2.88	2.74	2.64	2.63
5.0	3.32	3.32	3.32	3.32	3.32	3.32	3.32	3.07	2.79	2.64	2.63
5.5	3.32	3.32	3.32	3.32	3.32	3.32	3.32	3.32	2.88	2.64	2.63

<sup>1</sup>Measured at least 2.5h upstream of the weir

Note that  $L$  in Equation 9.04-3-1 is the width of the crest (measured along the crest of the dam) while  $b$  in Table 9.04-3-1 is the length of flow across the crest (perpendicular to the dam).

## NOTE

An extensive discussion of Site/Development vs. Regional stormwater management and the benefits and challenges of the scale of the practice and its ownership of best management practices is included in the Unified Sizing Criteria Section 3.01.

3. Text above adapted from Brater, E.F. and King, H.W., Handbook of Hydraulics, 6th ed. McGraw Hill Book Company (1976)

## C. V-NOTCH WEIRS

The discharge through a V-notch weir (Figure 9.04-3.4) can be calculated from the following equation (Brater and King, 1976).

Equation 9.04-3.2: Flow across a V-notch weir

$$Q = 2.5 \tan\left(\frac{\emptyset}{2}\right) h^{2.5}$$

Where:

Q = discharge (cfs)

$\emptyset$  = angle of V-notch (degrees)

h = head on apex of notch (ft)

Figure 9.04-3.4: Variable illustration for V-notch weirs

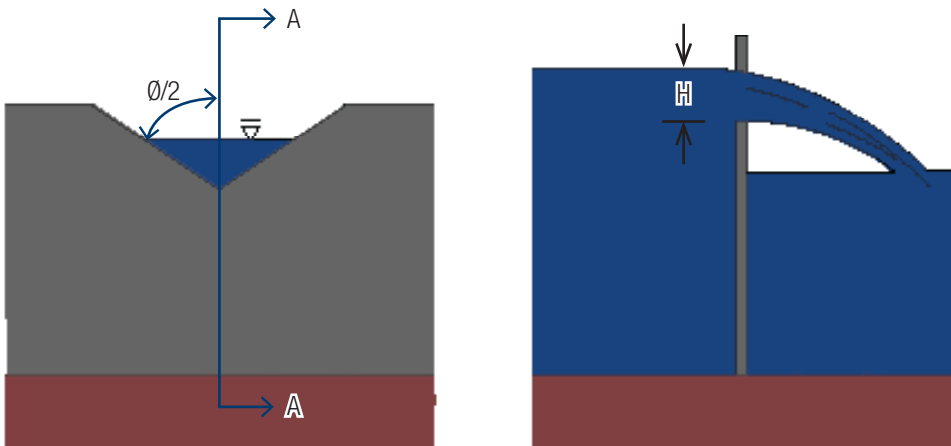

## D. TRAPEZOIDAL (CIPOLLETTI) WEIR

The Cipolletti (or trapezoidal) weir has side slopes in the vertical to horizontal ratio of 4:1. Cipolletti weirs are considered fully contracted, and are installed as described below. The discharge coefficient for Cipolletti weirs is 3.367 (in English units), and it does not depend on L or P as for the rectangular weir. The discharge coefficient formulation is simpler than for rectangular weirs, but the accuracy is somewhat decreased—about  $\pm 5\%$  (USB, 1997). The Cipolletti weir equation is shown below for Q in cfs (cubic feet per second), and head and length in feet units (USB, 1997).

Equation 9.04-3.3: For Cipolletti (trapezoidal) weirs

$$Q = 3.367Lh^{3/2}$$

Where:

Q = discharge (cfs)

L = weir length (ft)

h = depth of water above crest (ft)

Figure 9.04-3.5: Variable illustration for Trapezoidal weirs

End view

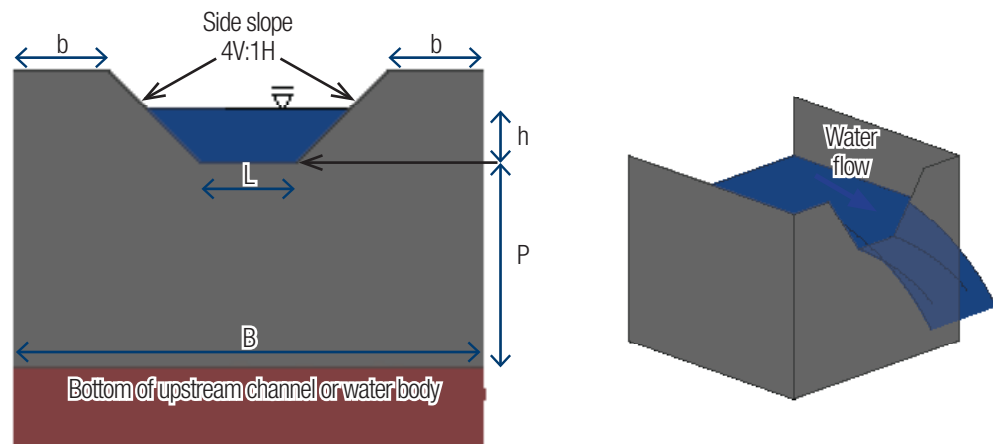

Note that L is measured along the bottom of the weir crest (not along the water surface). Weir side slopes should have a vertical-to-horizontal ratio of 4:1. Head (h) should be measured at a distance of at least 4h upstream of the weir.

It doesn't matter how thick the weir is, except where water flows through the weir. The weir should be between 0.03 and 0.08 inches thick at the opening. If the bulk of the weir is thicker than 0.08 inch, the downstream edge of the opening can be chamfered at an angle greater than 45° (60° is recommended) to achieve the desired thickness of the edges. Water surface downstream of the weir should be at least 0.2 feet below the weir crest (i.e., below the bottom of the opening).

Measured head (h) should be greater than 0.2 feet, but less than L/3. The distance P is measured from the bottom of the upstream channel to the crest of the weir, and should be greater than 2h<sub>max</sub>, where h<sub>max</sub> is the maximum expected head. b is measured from the sides of the channel and also should be greater than 2h<sub>max</sub>.

## E. PROPORTIONAL WEIRS

The proportional weir is distinguished from other control devices by having a linear head-discharge relationship achieved by allowing the discharge area to vary non-linearly with head.<sup>(4)</sup>

A typical proportional weir is shown in Figure 9.04-3-6. Design equations for proportional weirs are (Sandvik, 1985):

Equation 9.04-3.4:

$$Q = 4.97\sqrt{a}b\left(H - \frac{a}{3}\right)$$

Equation 9.04-3.5:

$$\frac{x}{b} = 1 - \left(\frac{1}{3.17}\right)\left(\arctan\sqrt{\frac{y}{a}}\right)$$

Where:

Q = discharge (cfs)

Dimensions a, b, H, x, and y are shown in Figure 9.04-3.6 (all in ft)

Figure 9.04-3.6: Proportional Weir Dimensions

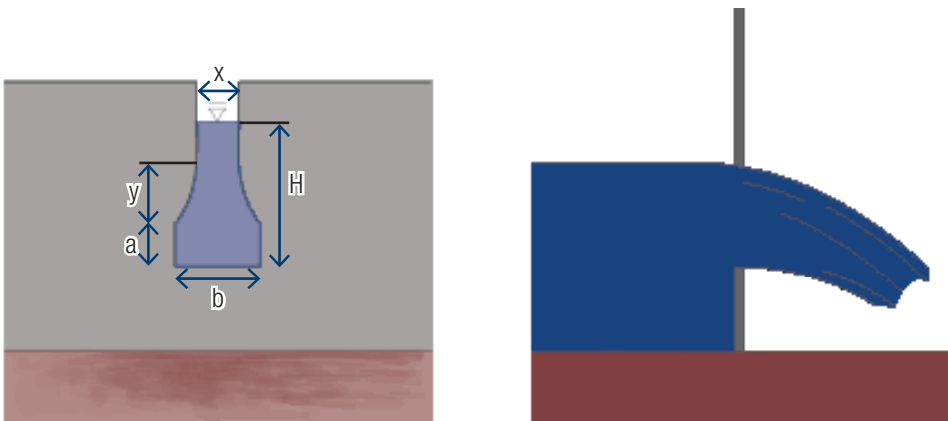

4. Adapted from Urban Drainage Manual (Hydraulic Engineering Circular No. 22, Third Edition, Sept 2009; Federal Highway Administration)

## 9.04-4 STANDPIPES AND INLETS

Standpipes and inlet boxes have intake openings that are parallel to the water surface, as shown in Figure 9.04-4.1. The structure is called a standpipe if it has a circular cross section and an inlet box if it has a rectangular cross section. Both surface openings discharge into a barrel sized large enough to prevent surcharge.

Figure 9.04-4.1:

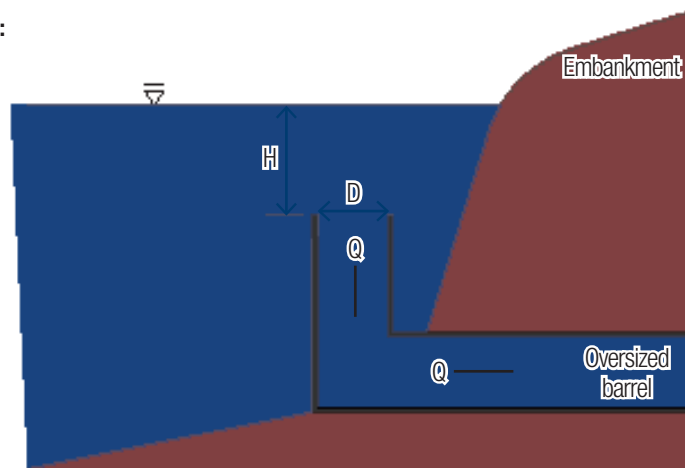

Standpipes and inlet boxes operate as weirs when the head over the structure is low (Equation C3-S12- 2). The crest length,  $L$ , is calculated as:

Equation 9.04-4.6: For circular standpipes

$$L = \pi D$$

Equation 9.04-4.7: For inlet boxes

$$L = 2B + 2D$$

For the equations above, these measurements should be taken from the dimensions around the walls along the inside of the structure.

The equations above are for standpipes and inlet boxes, respectively, where  $D$  = pipe diameter (ft) and  $B$  and  $D$  are the side lengths of the inlet box. It is important to note that the  $C_w$  coefficient for this type of structure will have a different value from rectangular weirs and need special attention to detail. At higher heads, the standpipe and inlet box will function as an orifice (Equation 9.04-2.1) will apply. The ranges over which the weir and orifice equation apply are not well established. The change from weir to orifice behavior occurs gradually over a transition depth. Typical practice is to use a transition head,  $h_T$ , defined as:

Equation 9.04-4.8: For inlet boxes

$$h_T = \frac{C_o A_o}{C_w L}$$

and use the weir equation for  $h < h_T$  and the orifice equation for  $h > h_T$ .

$C_o$  = orifice coefficient

$C_w$  = weir coefficient

$A_o$  = Area of orifice (area at inlet measured horizontally) (ft<sup>2</sup>)

$L$  = Length of weir (perimeter) (in ft)

# 9.04-5 MULTI-STAGE OUTLETS

Combinations of orifices, weirs, and pipes can provide multi-stage outlet control to restrict outflow to meet requirements of the Unified Sizing Criteria (e.g., water quality volume, channel protection volume, overbank flood protection volume, and/or extreme flood protection volume).

There are generally two types of combination outlets: shared outlet control structures and separate outlet controls. Shared outlet control is typically a number of individual outlet openings (orifices), weirs or drops at different elevations on a standpipe or inlet box which all flow to a common larger conduit or pipe.

Figure 9.04-5.1 shows an example of an outlet structure designed for multiple levels of control, including the lower-level control for the wet ED pond. The extended detention orifice plate outlet devices are sized to provide the total area needed to drain the ED volume with a draw-down period of at least 24 hours (refer to Section 3.02 for more information).

Figure 9.04-5.1: Multi-stage outlet example

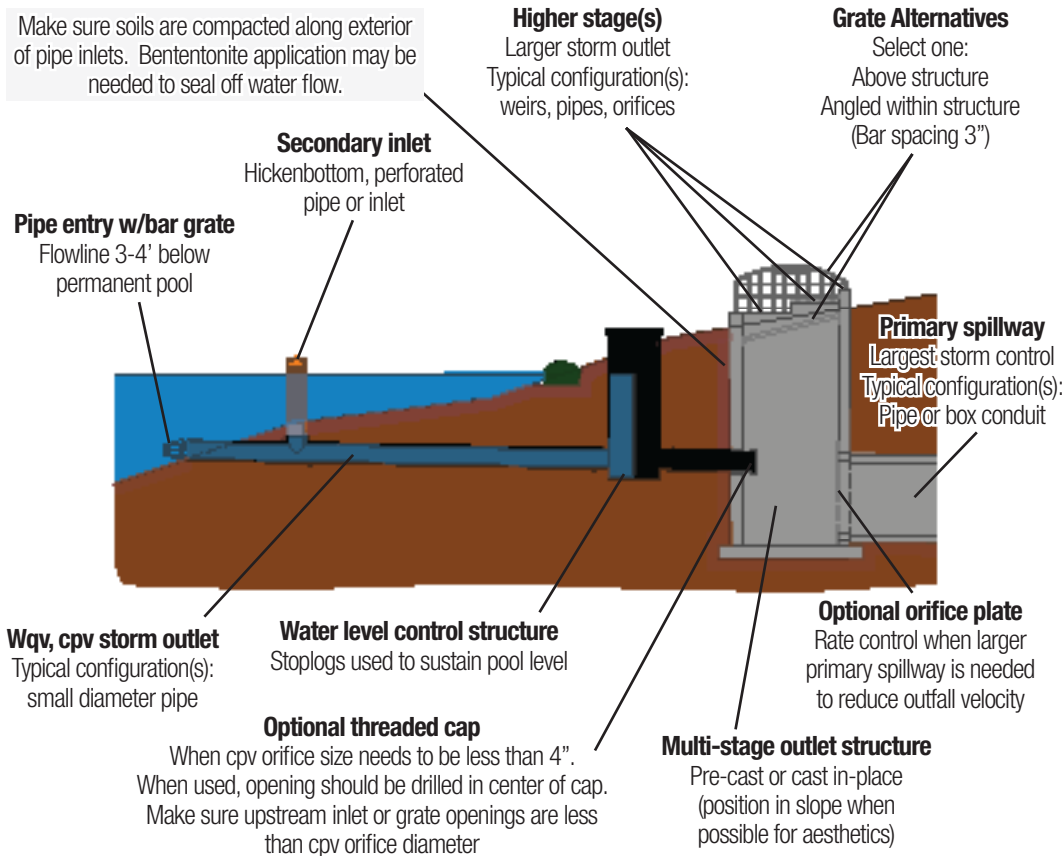

## NOTE

This arrangement is often defined as "multi-stage" by many routing software programs. Selecting "yes" for multi-stage operation tells the program that a given control will ultimately drain through the primary spillway of the multi-stage structure, often denoted as "Culvert A."

## A. DESIGN OF MULTI-STAGE OUTLETS

For the sizing of risers, it is necessary to first estimate the required volume of storage and then explore the physical characteristics of the riser. Methods to estimate required storage volume to meet USC requirements are included in Section 9.02.

The physical characteristics of the outlet structure include the outlet pipe diameter, the riser diameter, either the length of the weir or the area of the orifice, and the elevation characteristics of the riser. Standpipes or inlet boxes with weir flow and orifice flow are illustrated in Figure 9.04-5-2 and Figure 9.04-5-3, respectively. The equations used to define the relationship between the discharge ( $Q$ ) and the depth in feet ( $h$ ) above the weir or orifice are explained in Sections 9.04-2 and 9.04-3.

### NOTE

If depth above inlet becomes large enough, orifice condition may restrict flow, based on cross section area of inlet interior. See Section 9.04-4 for more information.

Figure 9.04-5.2: Example of a Multi-stage Outlet with Weirs on Top and Orifice on Side

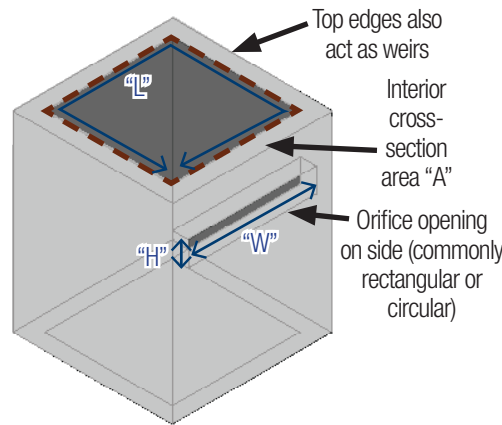
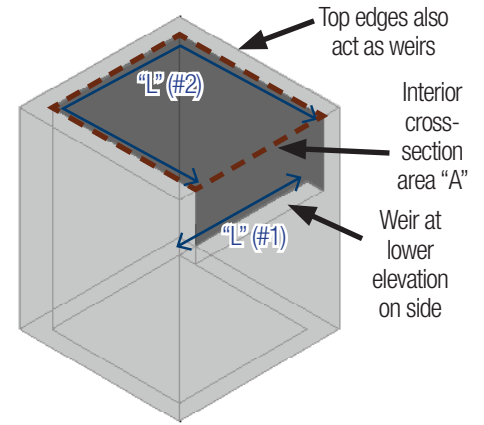
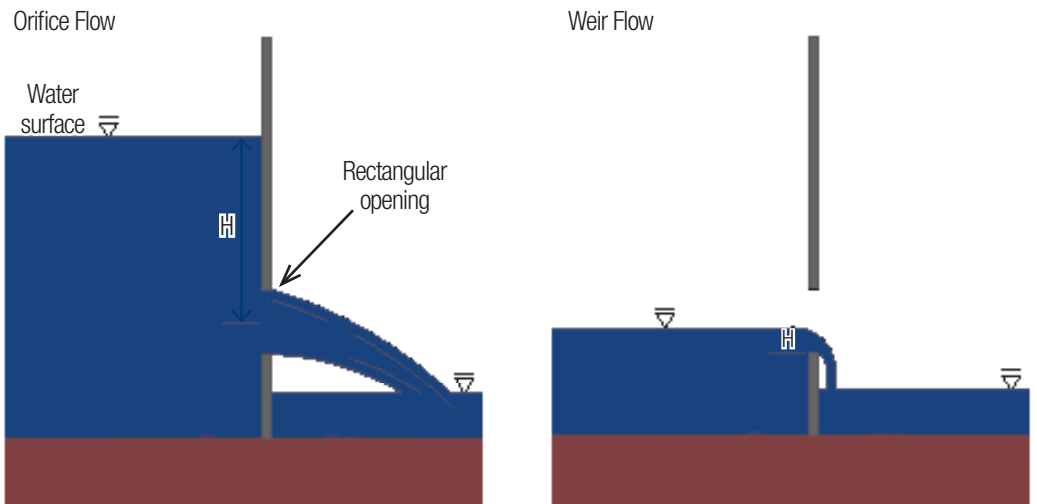

Figure 9.04-5.3: Example of a Multi-stage Outlet with Weirs on Top and Lower Weir on Side



The flow conditions for different water surface conditions can also alter the flow condition (orifice vs. weir) for the outlet structure, as illustrated in Figure 9.04-5-4. The flow condition changes from a weir to an orifice as the water surface elevation rises. The flow conditions in the standpipe or inlet box barrel and the outlet pipe can also impact the hydraulic performance of the structure.

Figure 9.04-5.4: Illustration of transition between orifice and weir flow conditions through an opening





Multi-stage outlets use separate openings or devices at different elevations and control the rate of discharge from a facility during both small and larger storm events. A number of iterative storage routings are usually required to arrive at a minimum structure size and storage volume that provides proper control. Currently, routing software programs allow for design iterations to be completed much more quickly than manual calculation required in the past.

The final stage-discharge table or rating curve will be a composite of the different outlets that are used for different elevations within the multi-stage outfall structure. Figure 9.04-5.5 shows an example of a multi-stage outfall structure.

Figure 9.04-5.5: Multi-stage outfall structure example

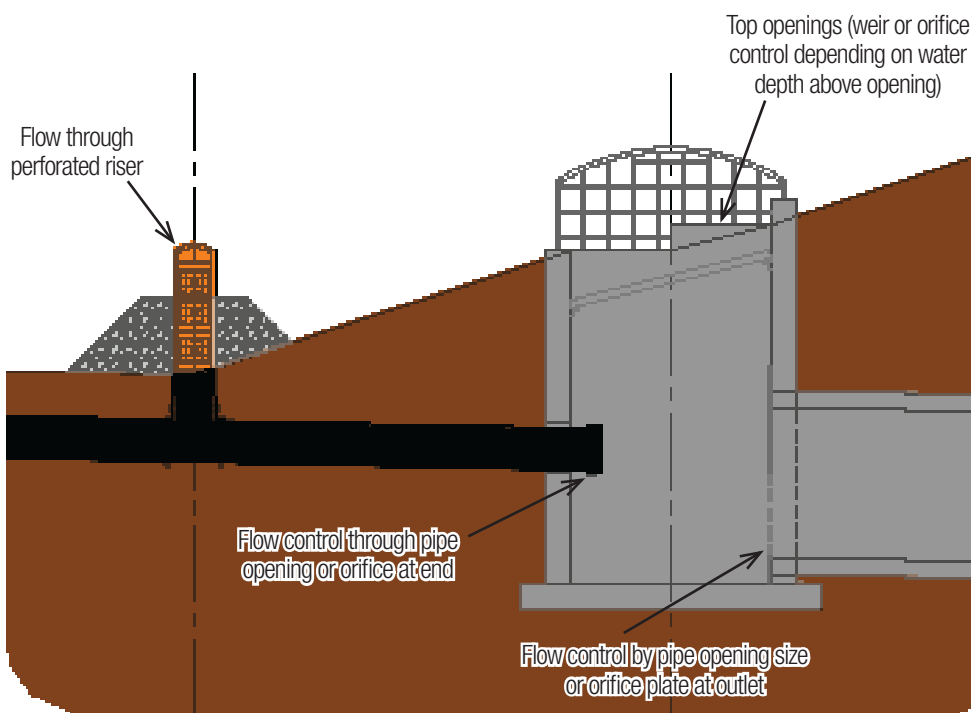

Many routing software programs automatically consider these effects when developing stage-storage relationships for multi-stage outfall design. Use of such programs is encouraged, to most accurately consider interactions among different outlet stages.

## NOTE

Multi-stage outlets may not require all the components shown in Figure 9.04-5.5.

Designs will vary as needed to provide various levels of flow control for smaller and larger storms.

## 9.04-6 LOW-FLOW INLET CONSIDERATIONS

Special design consideration is needed for low-flow inlets, to prevent clogging and to accommodate subsurface water withdrawal, where applicable.

### A. SUBSURFACE INLET DESIGNS

#### 1. HOODED OUTFALLS

A hooded outfall can prevent floatable materials from clogging a smaller-diameter orifice, often used to meet CPv release rate requirements. This application uses a circular or rectangular hood cast or fixed to the exterior of a storm inlet structure. This forces water to be drawn from below the water surface up to the orifice elevation, which establishes the normal pool elevation.

Figure 9.04-6.1: Subsurface inlet using debris hood

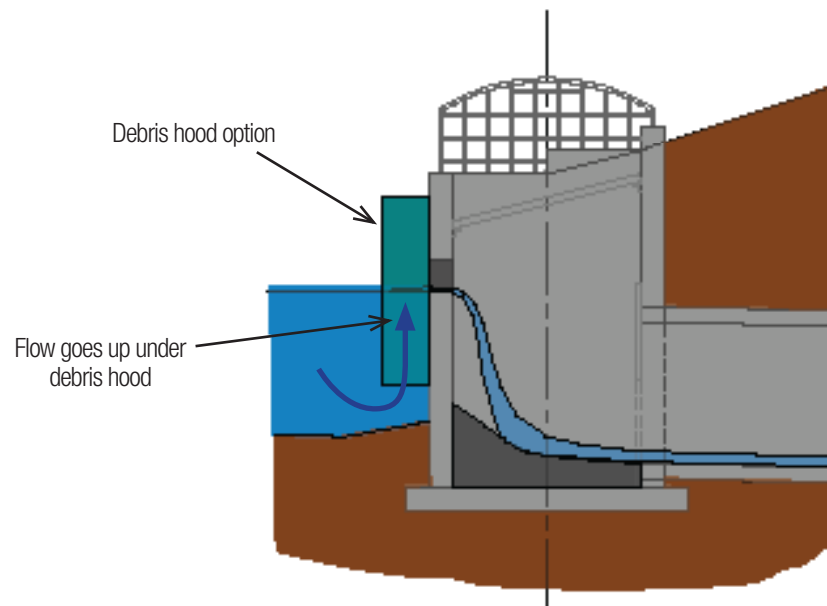

#### 2. WATER LEVEL CONTROL STRUCTURES

Water level control structures can draw water from several feet below the normal pool. This is most advantageous for stormwater wetlands and wet ponds. These structures use removable stop logs to establish the normal pool elevation. Water is drawn from below the surface through an inlet pipe. Water has to pass up and over the stop logs before passing out of the practice, or on to a multi-stage outlet structure.

These devices provide the ability to remove the stop logs, allowing water levels to be drawn down for maintenance, or filled in stages during the initial vegetation establishment periods.

Figure 9.04-6.2: Water Level Control Structure

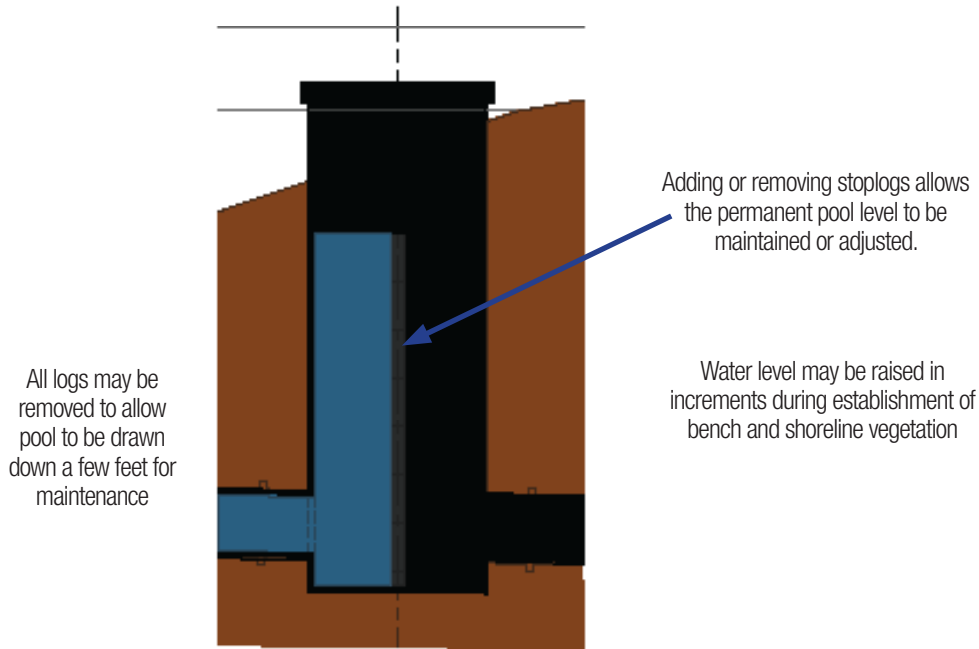

### 3. UPTURNED RISERS

Pipes can be installed that withdraw water below the water surface, but are turned upward within the multi-stage outfall structure. The upper end of the pipe establishes the normal pool elevation. In open-top multi-stage structures, the end of the upturned pipe could freeze during cold weather, preventing its operation during those times. These designs do not allow the normal pool elevations to be easily changed, unless a separate valve-controlled pipe is incorporated into the design.

Figure 9.04-6.3: Upturned Riser example

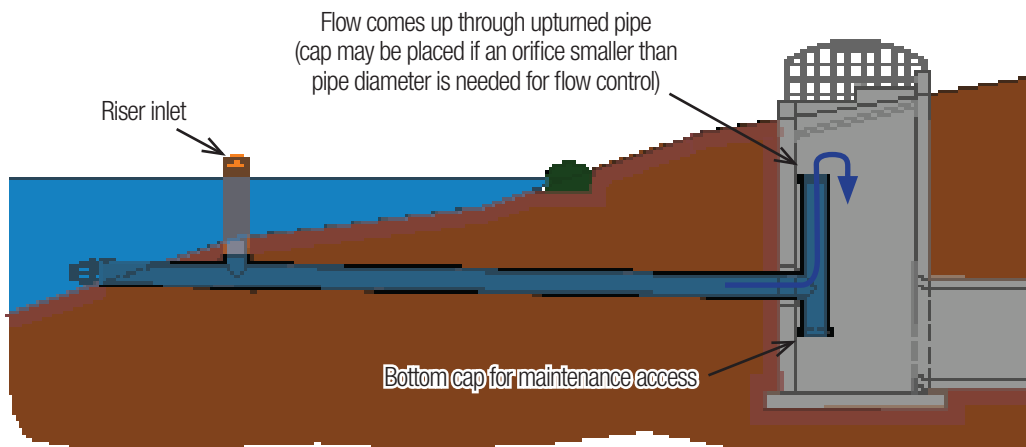

## B. SUBSURFACE INLET LINE PROTECTIONS

The subsurface line should be anchored below the water surface through installation of a concrete collar near the end of the pipe. The opening should be protected by a rodent guard to prevent animals or debris from entering the line. Incorporating a perforated riser as a secondary inlet provides a second method of water entry.

Figure 9.04-6.4: Subsurface inlet protections

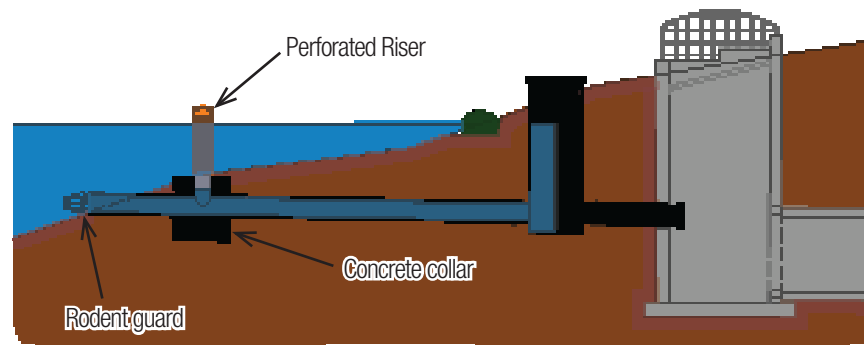

## 9.04-7 TRASH RACKS AND GRATES

Trash racks reduce the effects of clogging by debris and trash, allowing outlets to operate as intended. Improper trash rack design could allow outfalls to become clogged and not operate as needed during extreme storm events. Trash racks and safety grates are a critical element of outlet structure design and serve several important functions:

- Keeping debris away from the entrance to the outlet works to avoid clogging the critical portions of the structure
- Capturing debris in such a way that removal is relatively easy
- Ensuring that people and animals are kept out of confined conveyance and outlet areas
- Providing a safety system that prevents anyone from being drawn into the outlet, and allows them to climb to safety

### A. GENERAL PARAMETERS

The location and size of the trash rack depends on a number of factors, including head losses through the rack, structural convenience, safety and size of the outlet. Well designed trash racks can also have an aesthetically pleasing appearance.

An example of trash racks used on a riser outlet structure is shown in Figure 9.04-7-1. The inclined vertical bar rack is most effective for lower-stage outlets. Debris will ride up the trash rack as water levels rise. This design also allows for removal of accumulated debris with a rake while standing on top of the structure.

Figure 9.04-7.1: Trash rack arrangement options

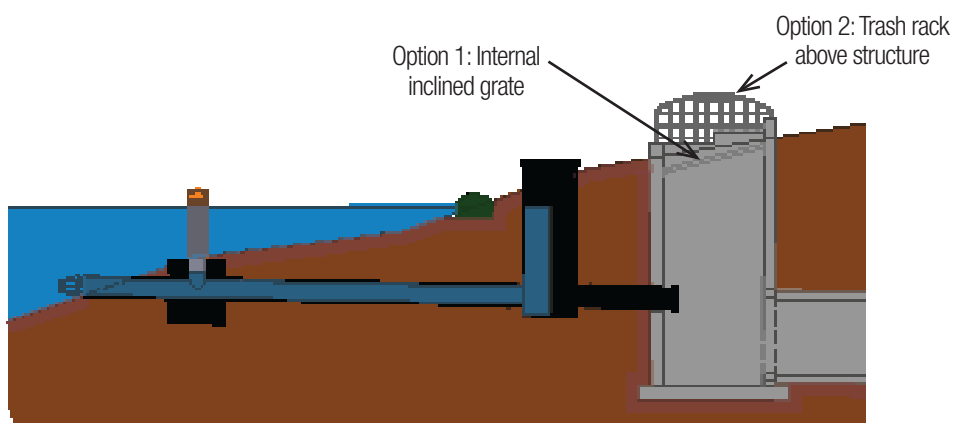

The trash racks must have a combined total open area such that partial plugging will not adversely restrict flows through the outlet works. While a universal guideline does not exist for stormwater outlets, a common rule of thumb is to provide a trash rack open area at least 10 times larger than the control outlet orifice (ASCE, 1992). The surface area of all trash racks should be maximized and the trash racks should be located a suitable distance from the protected outlet to avoid interference with the hydraulic capacity of the outlet. The spacing of trash rack bars must be based on the size of the smallest outlet protected (spacing of bars or openings should be smaller than the downstream opening being protected). Where a small orifice is provided, a separate trash rack for that outlet should be used, so that a simpler, sturdier trash rack with more widely spaced members can be used for the other outlets. Spacing of the rack bars should be wide enough to avoid interference but close enough to provide the level of clogging protection required. To facilitate removal of accumulated debris and sediment from around the outlet structure, the racks should have hinged connections. If the rack is bolted or set in concrete, it will preclude removal of accumulated material and will eventually adversely affect the outlet hydraulics.

Trash racks at entrances to pipes and conduits should be sloped at about 3:1 to 5:1 to allow trash to slide up the rack with flow pressure and rising water level; the slower the approach flow, the flatter the angle. Rack opening rules of thumb are found in various industry literature. Figure 9.04-7-2 gives opening estimates based on outlet diameter (UDFCD, 2005). Judgment should be used in an area with higher debris (e.g., a wooded area), which may require more opening space.

The bar opening space for small pipes should be less than the pipe diameter. For larger-diameter pipes, openings should be no greater than 6 inches. The following parameters should also be considered in trash rack design:

- Spacing less than 3 inches may be subject to clogging by floatable debris.
- To prevent passage of mature fish in ponds and wetlands, avoid spacing larger than 3 inches.
- Where the structures could be accessed by the public, avoid openings larger than 4 inches, which could allow bodily extremities to become stuck in the grate.

Collapsible racks are an option if clogging becomes excessive or if a person becomes pinned to the rack. Alternately, debris for culvert openings can be caught upstream from the opening by using pipes placed in the ground or a chain safety net (USBR, 1978; UDFCD, 1992). Racks can be hinged on top to allow for easy opening and cleaning. The control for the outlet should not shift to the grate, nor should the grate cause the headwater to rise above planned levels.

## B. HEAD LOSSES AND OPEN AREA

Head losses through the grate can be calculated. A number of empirical loss equations exist, though many have difficult to estimate variables. Two are provided below to allow for comparison.

ASCE/WEF (1992) provides the following equation (based on German experiments) for losses through bar screens. Grate openings should be calculated assuming a certain percentage blockage as a worst case to determine losses and upstream head. Often 40–50% blockage is chosen as a working assumption.

$$g=32.2 \text{ ft/s}^2$$

Equation 9.04-7.9:

$$H_g = K_{g1} \left(\frac{w}{x}\right)^{\frac{4}{3}} \left(\frac{V_u^2}{2g}\right) \sin \theta_g$$

Where:

$H_g$  = head loss through grate (ft)

$K_{g1}$  = bar shape factor

2.42 – sharp-edged rectangular

1.83 – rectangular bars with semicircular upstream faces

1.79 – circular bars

1.67 – rectangular bars with semicircular upstream and downstream faces

$w$  = maximum cross-sectional bar width facing the flow (in)

$x$  = clear spacing between bars (in)

$V_u$  = approach velocity (ft/s)

$\theta$  = angle of the grate in respect to horizontal (degrees)

Equation 9.04-7.10:

$$H_g = K_{g2} V_u^2 / 2g$$

Where:

$K_{g2}$  is defined from a series of fit curves as:

Sharp-edged rectangular (length/thickness = 10)

$$K_{g2} = 0.00158 - 0.03217A_r + 7.1789A_r^2$$

Sharp-edged rectangular (length/thickness = 5)

$$K_{g2} = -0.00731 + 0.69453A_r + 7.0856A_r^2$$

Round-edged rectangular (length/thickness = 10.9)

$$K_{g2} = 0.00101 + 0.02520A_r + 6.0000A_r^2$$

Circular cross-section

$$K_{g2} = 0.00866 + 0.13589A_r + 6.0357A_r^2$$

And  $A_r$  is the ratio of the area of the bars to the area of the grate section.

Secondary source: Municipal Stormwater Management by Thomas Debo and Andrew Reese | Feb 14, 1995  
<https://www.amazon.com/s?k=9781420032260&i=stripbooks&linkCode=qs>

Figure 9.04-7-2 is an alternate method used for selecting the trash rack size, based on the cross-sectional area of the outlet.

Figure 9.04-7-2. Minimum trash rack open area

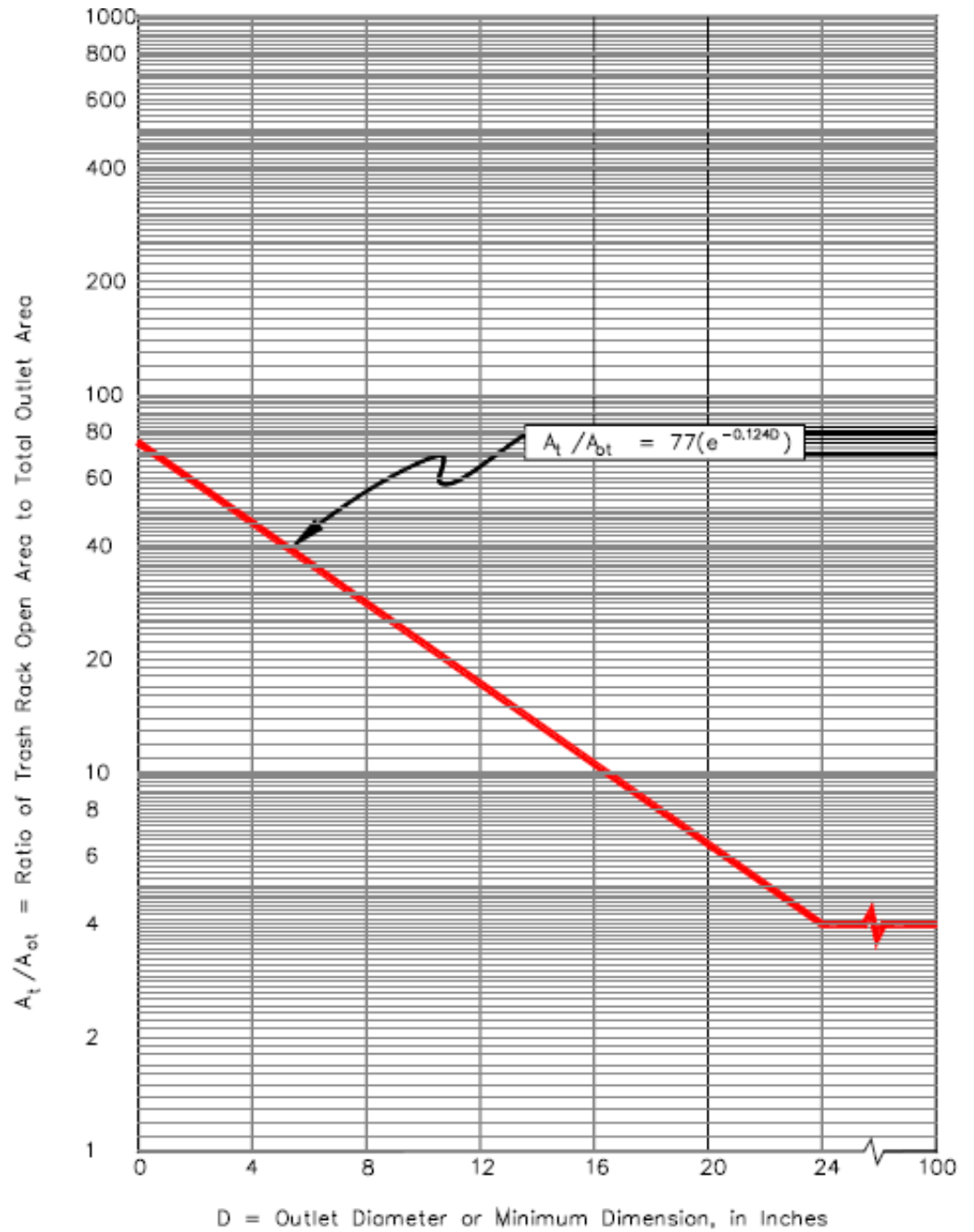

Source: Urban Drainage and Flood Control District, 2001 (Denver, CO)



## 9.04-8 AUXILIARY SPILLWAYS

Auxiliary spillway designs are open channels, usually trapezoidal in cross section, and consist of an inlet channel, a control section and an exit channel (see Figure 9.04-8-1). The auxiliary spillway is proportioned to pass flows in excess of the design flood (typically events greater than the 100-year flood) without allowing excessive velocities and without overtopping the crest of the dam embankment.

Once flow crests over the spillway, it operates as open channel flow. Both the approach and exit channels should have a consistent grade and an alignment without abrupt curves or changes in direction. Spillway side slopes should be no steeper than 3:1 horizontal to vertical.

### A. GENERAL PARAMETERS

The purpose of an auxiliary spillway is to provide a controlled overflow for flows in excess of the maximum design storm for a storage facility, or in the case that the outfall structure is not operating as designed due to debris, damage, etc. Figure 9.04-8-1 shows an example of an auxiliary spillway. For these smaller detention basins, the minimum threshold for auxiliary spillway design is conveyance of a 500-year flood discharge without overtopping the crest of the dam (the parts that are elevated above the emergency spillway). Basins that are large enough to require IDNR review of dam designs may require more extensive study to demonstrate compliance with state dam safety requirements.

General design criteria for auxiliary spillways are:

- Should only operate at floods greater than the primary spillway (pipe or conduit) design flood
- Flow velocities should be non-erosive:  $\approx 5$  fps (or reinforced to protect from erosion)
- Not constructed on fill material, when feasible (fill materials are more likely to erode when overtopped)
- Generally located near one end of the dam
- If it must be placed in an area of fill, use ramp spillway design (see Figure 9.04-8-1)
- Use smooth horizontal and vertical transitions and alignments
- Place outlet a safe distance from the downstream toe of the structure
- Consider need for surface protection and energy dissipation at the outlet

Design criteria for earthen auxiliary spillways are:

- Minimum bottom width: 10 feet
- For major structures, minimum depth is 3 feet below dam crest
- For non-major structures, minimum depth is 1.5 feet below dam crest
- For major structures, the profile through the auxiliary spillway should be horizontal for at least 30 feet through the crest control section
- Channel slopes: greater than 1%, but less than 10%

The most common type of emergency spillway is a broad-crested overflow weir cut through original ground next to the embankment. The transverse cross-section of the weir cut is typically trapezoidal in

shape for ease of construction. Such an excavated emergency spillway is illustrated below.

Figure 9.04-8.1: Auxiliary Spillway Design Schematic<sup>(5)</sup>

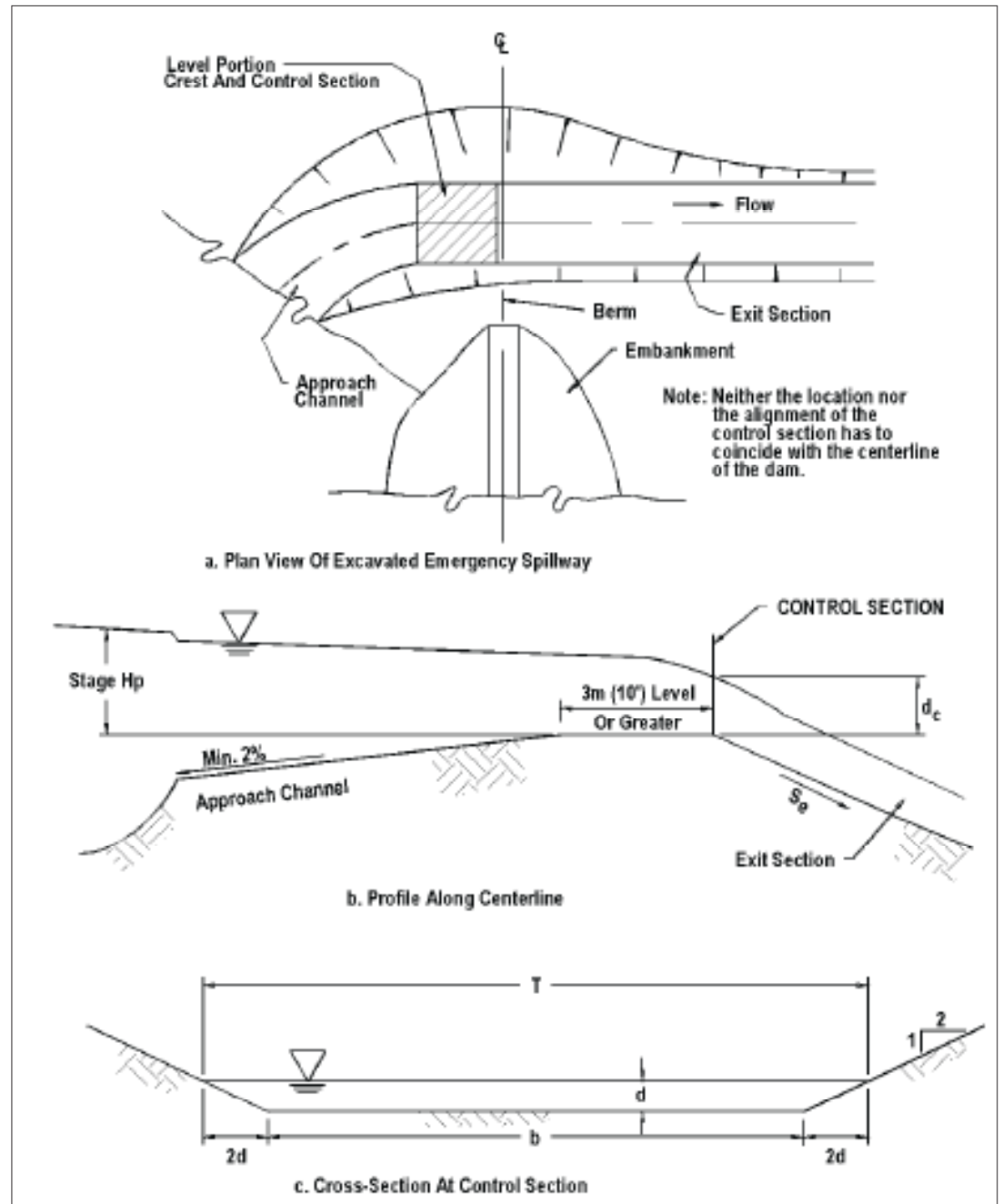

5. Urban Drainage Manual (Hydraulic Engineering Circular No. 22, Third Edition, Sept 2009; Federal Highway Administration)

## B. FLOW AND VELOCITY CALCULATIONS

---

Flow across an auxiliary spillway is calculated using the equations for broad-crested weirs. Velocity can be checked by dividing the expected flow rate (Q) by the cross-sectional area (A) during a given event. Area can generally be calculated by multiplying the width of the spillway crest by the expected depth of flow.

NRCS manuals provide guidance for the selection of emergency spillway characteristics for different soil conditions and different types of vegetation. The selection of degree of retardance for a given spillway depends on the vegetation. Knowing the retardance factor and the estimated discharge rate, the emergency spillway bottom width can be determined. For erosion protection during the first year, assume minimum retardance.

## C. REGULATORY REQUIREMENTS <sup>(6)</sup>

---

The Iowa DNR website currently has the following notes about permit requirements:

A DNR dam construction permit may be required to construct a dam, modify an existing dam, drawdown the water level, or remove a dam.

The thresholds for when a Flood Plain Permit from this department is required are outlined in 567 Iowa Administrative Code Chapter 71.3 and are listed below. The thresholds are primarily based on both dam height and water storage volumes. The height of a dam is defined as the vertical distance from the top of the dam to the lowest elevation at the downstream toe of the dam, typically the streambed.

### IN RURAL AREAS:

- Any dam designed to provide a sum of permanent and temporary storage exceeding 50 acre-feet at the top of dam elevation, or 25 acre-feet if the dam does not have an emergency spillway, and which has a height of 5 feet or more.
- Any dam designed to provide permanent storage in excess of 18 acre-feet and which has a height of 5 feet or more.
- Any dam across a stream draining more than 10 square miles.
- Any dam located within 1 mile of an incorporated municipality, if the dam has a height of 10 feet or more, stores 10 acre-feet or more at the top of dam elevation, and is situated such that the discharge from the dam will flow through the incorporated area.

### IN URBAN AREAS:

Any dam which exceeds the thresholds in 71.3(1) "a," "b" or "d."

### LOW HEAD DAMS:

Any low head dam on a stream draining 2 or more square miles in an urban area, or 10 or more square miles in a rural area. For additional information see low head dam guidance documents.

6. [www.iowadnr.gov/Environmental-Protection/Land-Quality/Dam-Safety](http://www.iowadnr.gov/Environmental-Protection/Land-Quality/Dam-Safety)

**MODIFICATIONS TO EXISTING DAMS ALSO REQUIRE PERMITTING:**

Modification or alteration of any dam or appurtenant structure beyond the scope of ordinary maintenance or repair, or any change in operating procedures, if the dimensions or effects of the dam exceed the applicable thresholds above. Changes in the spillway height or dimensions of the dam or spillway are examples of modifications for which approval is required.

More detailed information is included in the current version of Iowa DNR Technical Bulletin 16. No guidance in the Iowa Stormwater Management Manual shall be interpreted as waiving any dam safety or permitting requirements established by the State of Iowa.